

LIGHT (12V)

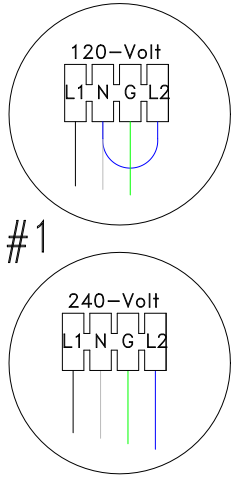
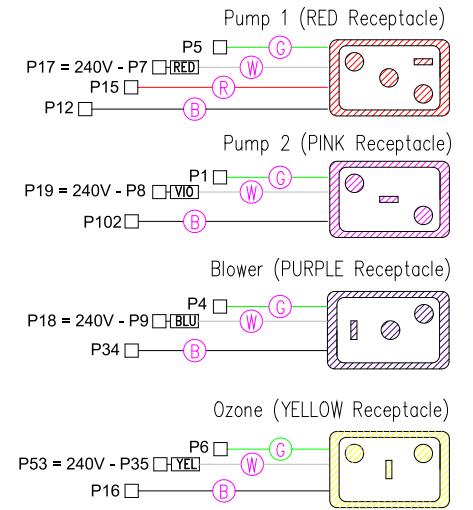
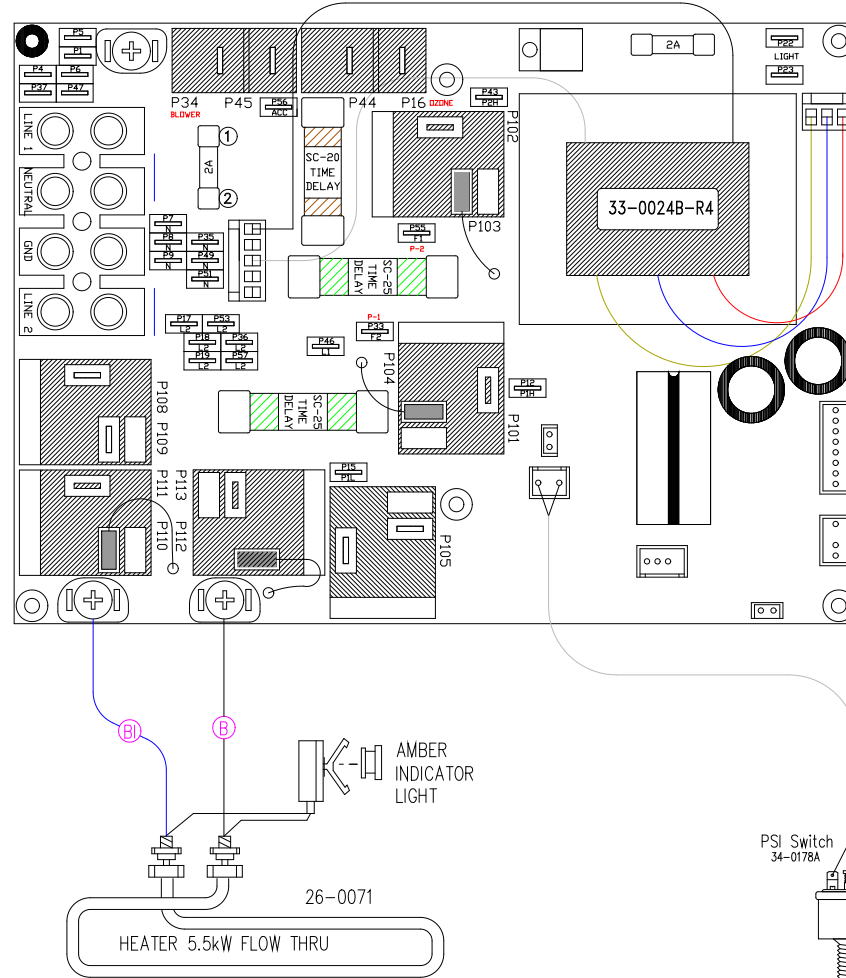

#1

LEGEND	
	- 1/4" QUICK CONNECT
	- 1/4" QUICK CONNECT PIGGYBACK
	- FORK CONNECTOR
	- RING CONNECTOR
	- SOCKET CONNECTOR
	- PIN CONNECTOR

HYDRO-QUIP
CORONA, CA (951) 273-7575

Manufacture Notes:

#1 Line 2 and Neutral need to be jumpered for 120V operation.

Drawn	Rev
GC	01
Date	01.17.07
Diagram No.	6817

Wire Color Code	
B - Black	G - Green
Br - Brown	Bl - Blue
R - Red	V - Violet
O - Orange	W - White
Y - Yellow	Gr - Gray